

- B
 - C
- 1-40A(30) 3-5 I_n 1-40A 30 5-10 I_n
- *

IEC / EN60898-1 GB 10963.1

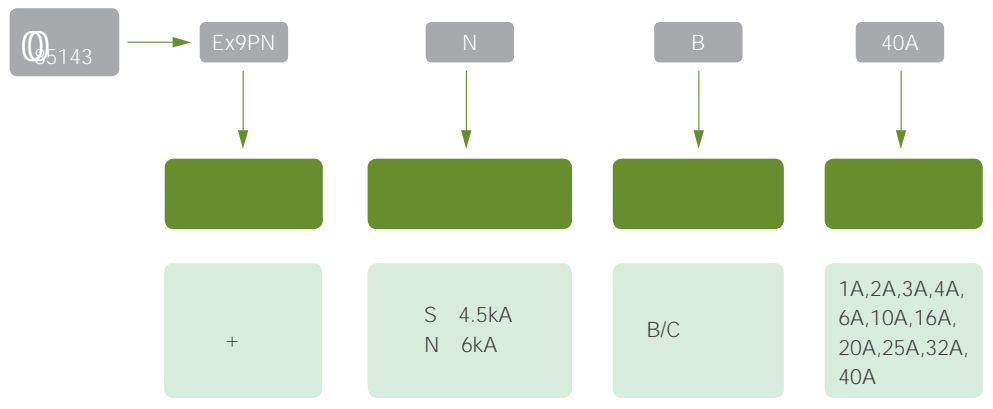



1P+N

Ex9PN

IEC/EN 60898-1 GB 10963.1

		20000			
		4000			
O~C		10000			
		4000			
		IP20			
		ON/OFF			
		mm ²			
		1~16			
		-30~+70			
		2			
		m			
		≤2000			
		+20		95% +40 50%	
		2			
		III			
		DIN			
		a			
		18			
		b			
		89			
		c			
		72			
		kg			
		0.12			

x x

mm

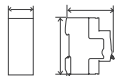

a





b

c

kg



Ex9PN-S

4.5kA B C

		mm	A	V AC		
		18	1	230	85111	Ex9PN-S B 1A
		18	2	230	85112	Ex9PN-S B 2A
		18	3	230	85113	Ex9PN-S B 3A
		18	4	230	85114	Ex9PN-S B 4A
		18	6	230	85115	Ex9PN-S B 6A
		18	10	230	85116	Ex9PN-S B 10A
		18	16	230	85117	Ex9PN-S B 16A
		18	20	230	85118	Ex9PN-S B 20A
		18	25	230	85119	Ex9PN-S B 25A
		18	32	230	85120	Ex9PN-S B 32A
		18	40	230	85121	Ex9PN-S B 40A
				18	1	230
18	2			230	85123	Ex9PN-S C 2A
18	3			230	85124	Ex9PN-S C 3A
18	4			230	85125	Ex9PN-S C 4A
18	6			230	85126	Ex9PN-S C 6A
18	10			230	85127	Ex9PN-S C 10A
18	16			230	85128	Ex9PN-S C 16A
18	20			230	85129	Ex9PN-S C 20A
18	25			230	85130	Ex9PN-S C 25A
18	32			230	85131	Ex9PN-S C 32A
18	40			230	85132	Ex9PN-S C 40A

Ex9PN-N

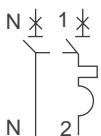
6kA B C

		mm	A	V AC		
		18	1	230	85133	Ex9PN-N B 1A
		18	2	230	85134	Ex9PN-N B 2A
		18	3	230	85135	Ex9PN-N B 3A
		18	4	230	85136	Ex9PN-N B 4A
		18	6	230	85137	Ex9PN-N B 6A
		18	10	230	85138	Ex9PN-N B 10A
		18	16	230	85139	Ex9PN-N B 16A
		18	20	230	85140	Ex9PN-N B 20A
		18	25	230	85141	Ex9PN-N B 25A
		18	32	230	85142	Ex9PN-N B 32A
		18	40	230	85143	Ex9PN-N B 40A
				18	1	230
18	2			230	85145	Ex9PN-N C 2A
18	3			230	85146	Ex9PN-N C 3A
18	4			230	85147	Ex9PN-N C 4A
18	6			230	85148	Ex9PN-N C 6A
18	10			230	85149	Ex9PN-N C 10A
18	16			230	85150	Ex9PN-N C 16A
18	20			230	85151	Ex9PN-N C 20A
18	25			230	85152	Ex9PN-N C 25A
18	32			230	85153	Ex9PN-N C 32A
18	40			230	85154	Ex9PN-N C 40A

■ Ex9PN/小



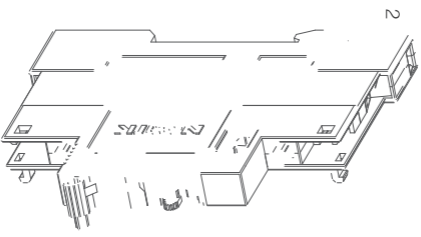

Ex9B/Ex9PN/Ex9BD/Ex9BP

5

- AL3111/AXL31

- UVT31/UVT3101/UVT3110

AXL31

UVT31

70%-35%Ue

85%-110%Ue

- AX3111/AX3122

- OVT31

- SHT31/SHT3111

280V± 5%

SHT31

AL31/AXL31/AX31

IEC/EN 60947-1 GB14048.1

	V	A
AC	240	6
	415	3
	24	6
DC	48	2
	130	1

IEC/EN 60947-5-1 GB14048.5

18mm

36mm



AL31/AXL31



AX31



SHT31



UVT31



OVT31



Ex9B

-
-
-
-

2

3

1

2

2